

METER SHUNTS

Below is the formula for calculating shunt values for use with meters.



To design a voltage multiplier, use:

$$R_x = \frac{V}{A} - R_m$$

Where...

- V = FSD voltage required
- A = FSD current of meter
- R_m = Meter resistance
- R_x = Required shunt

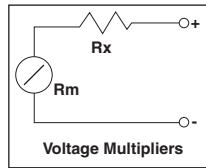

To design a current shunt, use:

$$R_s = R_m \times \frac{A_m}{A_t - A_m} - R_m$$

Where...

- A_m = FS current of meter
- A_t = FS current required
- R_m = Meter resistance
- R_s = Required shunt

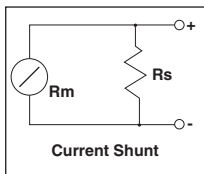

LOGIC GATES

NOR Gate: Output is a logic "1" only if both inputs are "0". A logic "1" at either or both inputs produces a logic "0" output.

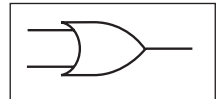

AND Gate: Output is a logic "1" only if both inputs are "1". A logic "0" at either or both inputs produces a logic "0" output.

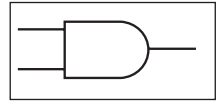

OR Gate: Output is a logic "0" only if both inputs are "0". A logic "1" at either or both inputs produces a logic "1" output.

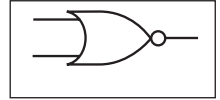

NAND Gate: Output is a logic "0" only if both inputs are "1". A logic "0" at either or both inputs produces a logic "1" output.

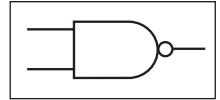

Inverter or NOT gate: Output is a logic "1" when input is "0". Output is a logic "0" when input is "1". ie Inverts the input state.

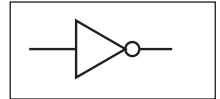

D Flip-Flop: Transfers the input at D to the output at Q (and it's inverse to Q-bar), on the rising edge of the clock signal at C. No change in any outputs on the falling edge of the clock pulse.

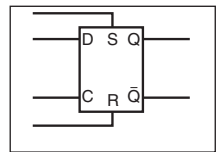

LM386 AUDIO POWER AMPLIFIER IC

The LM386 Audio Power Amplifier has a gain which may be set from 20 to 200, and can drive loads between 4 and 16 ohms. It's a very useful low voltage audio amplifier IC.

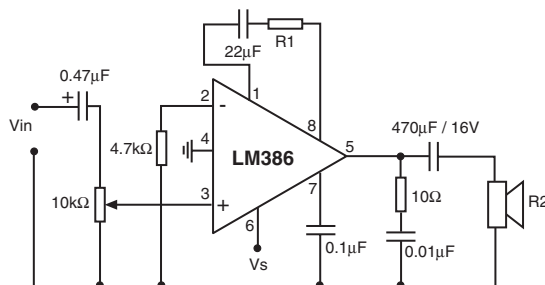
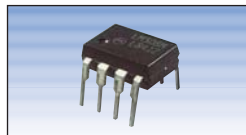

LM386 Gain	R1
20	∞
50	680
100	180
200	0

Vs	Output Power (mW)		
	4Ω	8Ω	16Ω
5V	190	160	90
6V	250	250	150
9V	380	560	400
12V	380	660	780

LM1875 20W AUDIO POWER AMPLIFIER IC

- Supply Voltage:±30V max.
- Supply Current:100mA max.
- THD at 20W @ 1kHz:0.015%
- Open Loop Gain:90dB
- Current Limit:4A

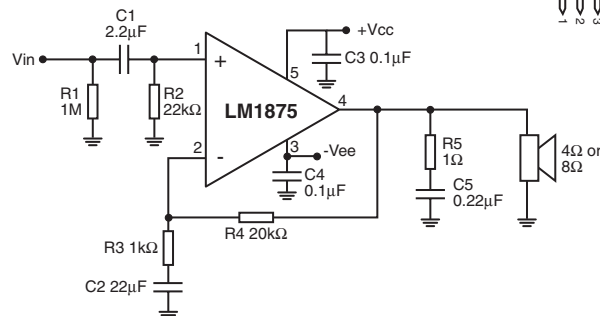
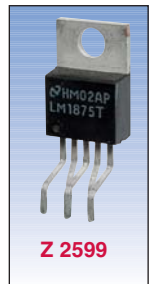
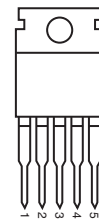

INDUCTANCE

Also known as chokes, a device, usually a coil of wire which possesses inductance. The basic construction is wire, wound around a cylinder with or without a ferrous metal insert. Inductors have interesting and useful property changes which are dependent on frequency. Inductance is measured in Henries. The formulas for inductors in series and parallel are identical to those of resistors.

