



## Operating Manual A 4432 4+4 CHANNEL MIXER

### Optional Accessories



**A 4433** Source Selection Plate



**A 4931** Local Input Plate



**A 4932** Local Input Box

User manual revision number: 1.1 25/06/2019

Distributed by Altronic Distributors Pty. Ltd.

Phone: 1300 780 999 Fax: 1300 790 999 Internet: [www.altronics.com.au](http://www.altronics.com.au)

### IMPORTANT NOTE:

Please read these instructions carefully from front to back prior to installation.  
They include important setup instructions.  
Failure to follow these instructions may prevent the unit from working as designed.

**REDBACK** is a registered trademark of Altronic Distributors Pty Ltd

Since 1976 Redback amplifiers have been manufactured in Perth, Western Australia by Altronic. With close to 40 years experience in the commercial audio industry, we offer consultants, installers and end users reliable products of high build quality with local product support. We believe there is significant added value for customers when purchasing an Australian made Redback amplifier or PA product

## **Australian Made Status**

All Redback house products made by Altronic will now be sporting the official Australian Made logo. Since starting manufacturing of commercial audio equipment in the mid 70's we have always taken pride in producing a quality local product.

The new adoption of the Australian Made logo will help us get the word out to local and export markets that our products carry the official compliance seal of the Australian Made campaign. We have always pushed our 'local is better' line in all of our marketing efforts, it's always an added boost when you are backed up by a widely recognised and respected icon.

## **Industry leading 10 year warranty.**

There's a reason we have the industry leading DECADE warranty. It's because of a long tried and tested history of bulletproof reliability. We've heard PA contractors tell us they still see the original Redford amplifier still in service in schools - that's over 39 years of operation - and still going strong!

## 1.0 INTRODUCTION

This mixer has been developed as a request from leading audio installation companies.

It combines 4 channels of the ever reliable front end Redback Mixers along with four switch selectable RCA inputs. Inputs 1 - 4 are able to be configured for either mic or line use. Mic inputs are 5 pin pluggable euro blocks allowing either PTT or VOX muting. Euro blocks allow for easy field installation. Line inputs are 2 x RCA. Dip switches are provided for each input enabling phantom power on/off, line level sensitivity setting from 100mV - 1V, and priority on/off.

Input 5 consists of 4 sets of 2 x RCA sockets which are selected by the front panel switches. This allows for several different music sources to be connected and selected as desired. A front mounted 3.5mm audio jack for portable devices will override the fourth input set of RCA's when connected.

The cascading priority structure has input 1 overriding all inputs. Inputs 1 - 4 automatically mutes input 5.

Alert and Evac tones along with pre-announcement chimes are in built and assumes priority between inputs 1 and 2.

These user changeable tones are MP3 based and stored on the internal Micro SD card.

Each input is supplied with volume control along with individual recessed treble and bass controls. Inputs 1 - 4 have adjustable VOX sensitivity controls.

A 24V DC output (limited to 120mA current draw) becomes live when any triggers are activated or VOX/PTT circuitry becomes active.

Provision is included to connect a remote wallplate A 4433 via Cat5 cable to enable remote selection of any of the 4 sources connected to input 5 along with remote volume adjustment.

Further to this, connecting either the A 4931 remote input plate or A 4932 remote input box to the A 4433 allows connection of a music source or microphone from a remote location. When active this will automatically mute any music source connected to input 5.

The unit operates from 24V DC and has provision for battery back up.

## 2.0 FEATURES

- 4 mic / line Input channels (Inputs 1-4)
- Four switched RCA AUX input channels (Input 5)
- Remote AUX source selection, volume control via A 4433
- Local input source volume control (via optional A 4931 or A 4932)
- PTT Input and 24V PTT output
- In built Alert/Evac/Chime functionality (MP3 based)
- Individual level, bass and treble controls
- 3.5mm music input on front panel
- Three levels of priority
- Adjustable vox sensitivity on inputs 1-4
- Adjustable input sensitivity
- Phantom Power on inputs 1-4
- Tape out
- Balanced Output
- LED VU meter
- MP3 active indicator
- Signal Present indicator
- 24V DC switched output
- 24V DC input
- 24V DC battery back up terminals
- 10 Year Warranty
- Australian designed & assembled

## 3.0 WHAT'S IN THE BOX

A 4432 4+4 Channel Mixer  
24V 1A DC Plugpack  
Instruction Booklet

# Redback® A 4432 4+4 Channel Mixer

## 4.0 FRONT PANEL GUIDE

Fig 1 shows the layout of the A 4432 front panel.

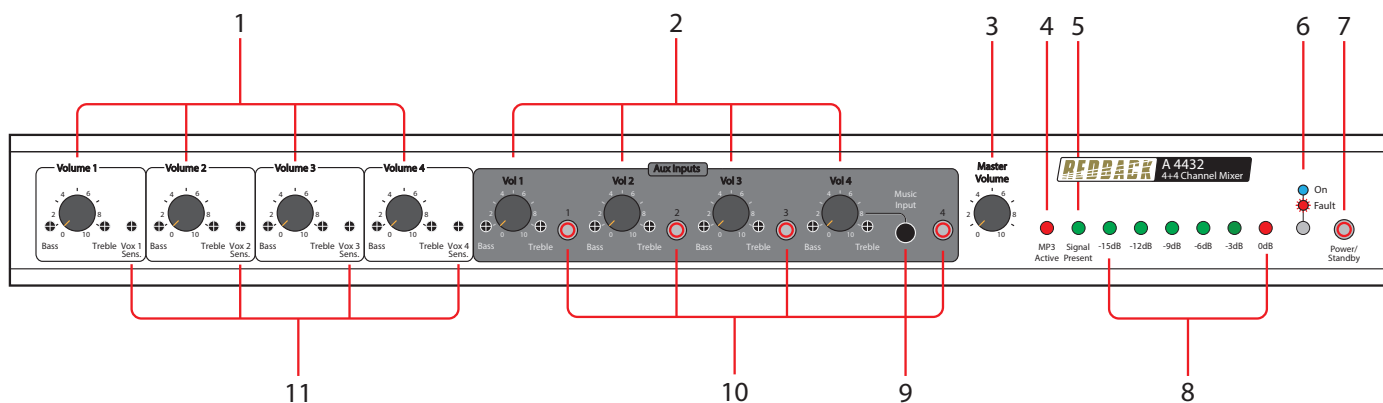

Fig 1

- 1 Inputs 1-4 volume controls**  
Use these controls to adjust the output volume, bass and treble of inputs 1-4.
- 2 Aux Inputs 1-4 volume controls**  
Use these controls to adjust the output volume, bass and treble of Aux Inputs 1-4.
- 3 Master Volume**  
Use this control to adjust the master volume.
- 4 MP3 Active Indicator**  
This LED indicates when an MP3 is playing.
- 5 Signal Presence Indicator**  
This LED indicates when a signal is present at any of the inputs.
- 6 On/Fault Indicator**  
This led indicates when the unit has power if the LED is blue. If the LED is red a fault has occurred with the unit.
- 7 Standby Switch**  
When the unit is in standby mode this switch will illuminate. Press this button to switch the unit ON. Once the unit is ON the On indicator will illuminate. Press this switch again to put the unit back in standby mode.
- 8 LED VU Meter**  
This LED bargraph provides a visual indication of the output signal.
- 9 Music input**  
This input will override AUX Input 4 when connected. Use this for connection of portable music players.
- 10 Input 5 AUX Input Selections Switches**  
These switches select/indicate which of the four AUX inputs are active on input 5.
- 11 VOX Sensitivities**  
These trimpots set the VOX sensitivities of input 1-4.

## 5.0 REAR PANEL CONNECTIONS

Fig 2 shows the layout of the A 4432 rear panel.

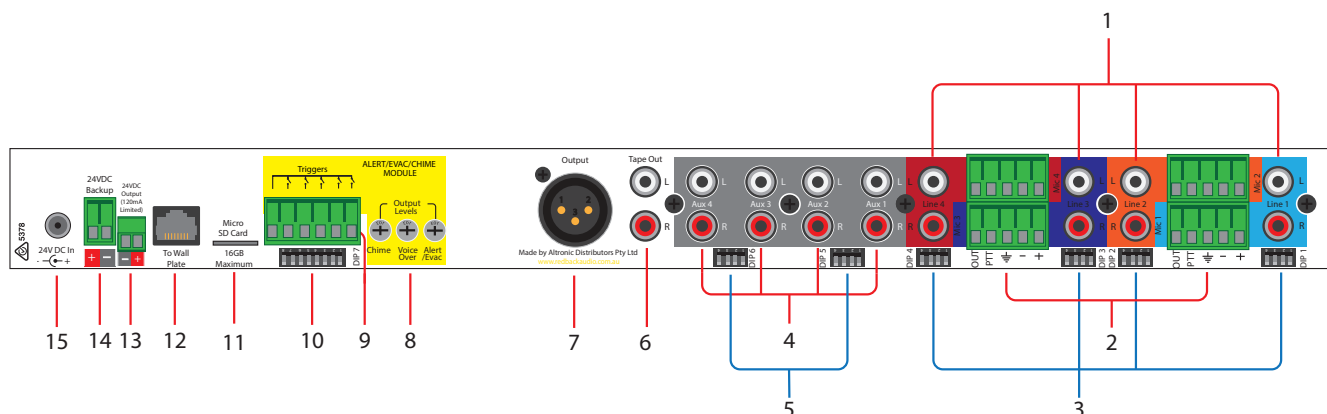

Fig 2

### 1 RCA Inputs 1 - 4

The line inputs are dual RCA connectors which are internally mixed to produce a mono input signal. The input sensitivity of these inputs can be adjusted to 100mV or 1V via the DIP switches DIP1 - DIP4 (refer to DIP switch settings).

### 2 Microphone Inputs 1 - 4

There are four microphone inputs which all incorporate a 5 way euro connector. Phantom power is available on each Mic input and is selected via DIP switches on DIP1 - DIP4 (For more details see DIP switch settings). A PTT connection is also available for PTT muting and a 24V DC (limited to 120mA current draw) output is provided for each microphone for activation of external indicators. (The PTT and 24V DC OUT connections are wired using the ground as a common connection).

### 3 Dip Switches DIP1 - DIP4

These are used to select various options on Inputs 1 -4, such as phantom power on mic inputs, VOX options and input sensitivities. Refer to DIP Switch Settings section.

### 4 Input 5 (AUX Inputs 1 - 4)

These AUX inputs are dual RCA connectors which are internally mixed to produce a mono input signal. The input sensitivity of these inputs can be adjusted to 100mV or 1V via the DIP switches DIP5 - DIP6 (refer to DIP switch settings).

### 5 Dip Switches DIP5 - DIP6

These are used to select the input sensitivities of the Input 5 (AUX inputs 1 - 4). Refer to DIP Switch Settings section.

### 6 Tape Out

Dual RCA's provide a line level output for recording purposes or to pass the output on to another amplifier.

### 7 Preamp Out (Balanced Line Output)

A three pin 600 ohm 1V balanced XLR output is provided for passing the audio signal on to a slave amplifier or to record the output of the amplifier.

### 8 Alert, Evacuation, Chime and Voice Over Message Volumes

Use these trimpots to adjust the output levels of the alert and evacuation tone and the chime and voice over message.

### 9 Alert, Evacuation, chime and cancel contacts

Use these contacts to trigger the chime tones, the alert tone, the evacuation tone and to cancel any of the tones once triggered. All tones & cancel function are operated by a closing contact to ground. This could be triggered via building fire indicator board, break glass alarm etc.

### 10 DIP 7

These switches provide various play modes (see DIP switch settings for more details).

### 11 Micro SD Card

This is used to store the MP3 audio files for the Alert, Evacuation and Chime tones and the Voice Over message. The Micro SD card needs to be pushed in to insert and to remove.

### 12 RJ45 Interface

This is for connection of the A 4432 wall plate (optional).

### 13 24V DC Out

This is a 24V DC output which is activated when any of the Alert, Evacuation or Chime triggers are operated. It also becomes active when any of the VOX circuits are enabled or any of the PTT muting is activated.

### 14 24V DC Input (Backup)

Connects to a 24V DC backup supply with at least 1 amp current capacity. (Please observe the polarity)

### 15 24V DC input

Connects to a 24V DC Plugpack with 2.1mm Jack.

# Redback® A 4432 4+4 Channel Mixer

## 6.0 CONNECTIONS

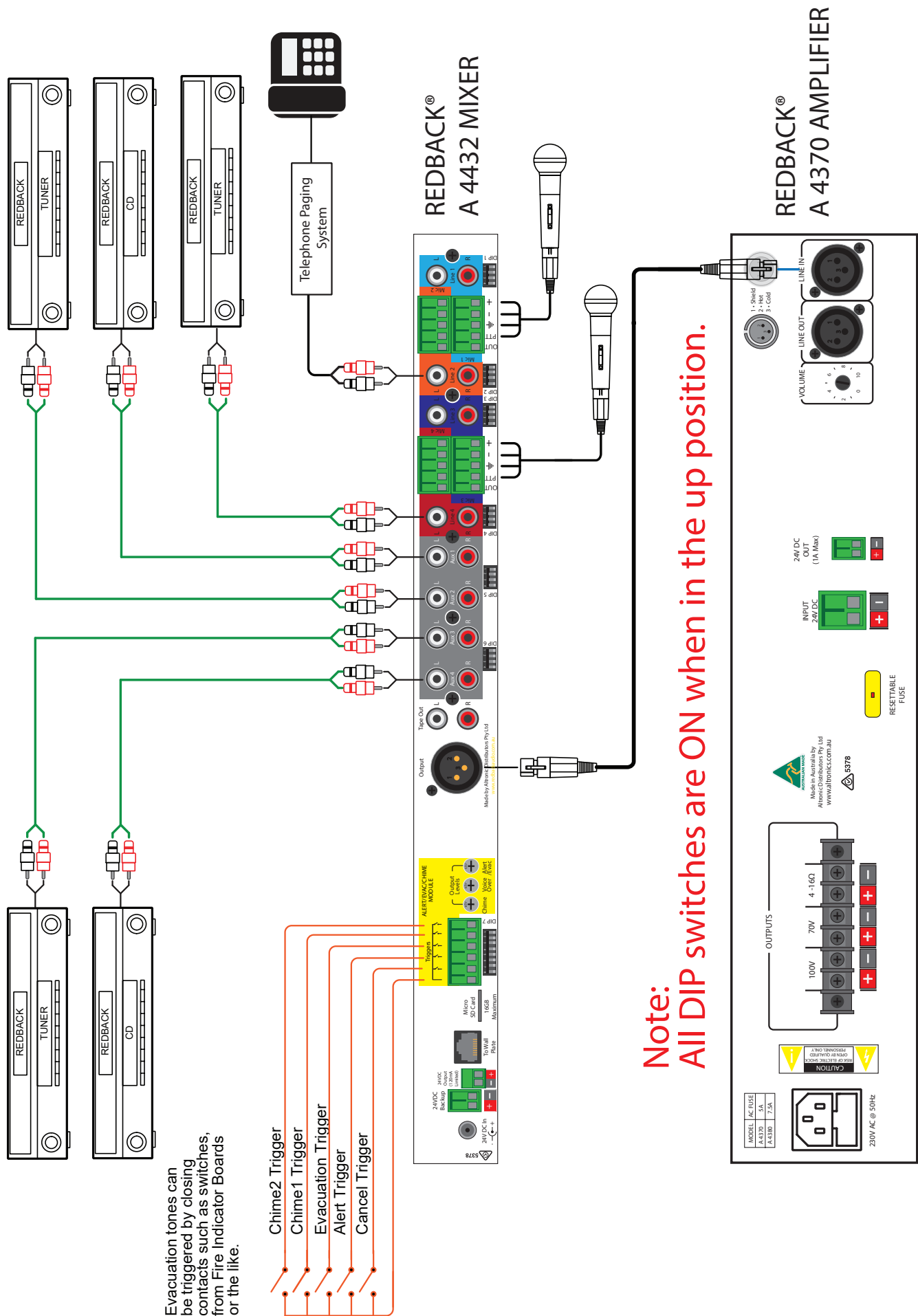

Evacuation tones can be triggered by closing contacts such as switches, from Fire Indicator Boards or the like.

- Chime2 Trigger
- Chime1 Trigger
- Evacuation Trigger
- Alert Trigger
- Cancel Trigger

**Note:**  
All DIP switches are ON when in the up position.

Fig 3

Figure 3 demonstrates a basic install with eight input sources. The VOX priorities are set for 3 levels of priority, so that the microphone on input 1 has the highest priority. The input 1 DIP1 switch settings are set for a 100mV sensitivity balanced microphone input with the priority/VOX enabled which makes this input priority level 1. (Refer to section 7.0 for more details about DIP switch settings).

Input 2 is connected to a telephone paging system with a line level output. The Input 2 DIP2 switch settings are set for a line level input with 1V input sensitivity and the VOX is enabled which makes this input priority level 2.

Input 3 is shown with a microphone connected. The Input 3 DIP3 switch settings are set for a 100mV sensitivity balanced microphone input and with the VOX enabled which makes this input priority level 3.

Input 4 is set as a line level input with a sensitivity of 1V and the VOX priority disabled.

Input 5 (AUX 1 - AUX 4) inputs are all set to 1V sensitivity via DIP 5 and DIP 6.

The output of the mixer is fed into a power amplifier which drives the speakers.

All DIP switch settings are shown below. *NOTE: The switches are ON when in the up position.*

**Input 1 Settings**

DIP 1 SW1 set to OFF - Phantom power disabled

SW2 set to ON to enable the VOX/priority

SW3 set to OFF

SW4 set to OFF to set Input to Microphone Input

**Input 2 Settings**

DIP 2 SW1 set to OFF - Phantom power disabled

SW2 set to ON to enable the VOX/priority

SW3 set to ON - Line Input Sensitivity set to 1V

SW4 set to ON to set Input to line Input

**Input 3 Settings**

DIP 3 SW1 set to OFF - Phantom power disabled

SW2 set to ON to enable the VOX/priority

SW3 set to OFF

SW4 set to OFF to set Input to Microphone Input

**Input 4 Settings**

DIP 4 SW1 set to OFF - Phantom power disabled

SW2 set to OFF to disable the VOX/priority

SW3 set to ON - Line Input Sensitivity set to 1V

SW4 set to ON to set Input to line Input

**Input 5 AUX1 & AUX 2 Settings**

DIP 5 SW1 set to ON - AUX 1 input set to 1V sensitivity

SW2 Not Used

SW3 Not Used

SW4 set to ON - AUX 2 input set to 1V sensitivity

**Input 5 AUX3 & AUX4 Settings**

DIP 6 SW1 set to ON - AUX 3 input set to 1V sensitivity

SW2 Not Used

SW3 Not Used

SW4 set to ON - AUX 4 input set to 1V sensitivity

# Redback® A 4432 4+4 Channel Mixer

## 7.0 DIP Switch settings

The A 4432 has 7 sets of DIP switches.

DIP1 - DIP6 select the inputs 1 - 6 as either Mic or Line, sets the Line Input level sensitivity, enables phantom power and enables VOX priorities for inputs 1-6 as outlined below.

(\* Priority/VOX muting is only available for inputs 1-6. Inputs 7-8 have no priority levels.)

### DIP 1

**Switch 1** - ON - Enables Phantom power to the Mic on input 1.

**Switch 2** - ON - Sets Input 1 priority or VOX to ON.

**Switch 3** - Sets Line 1 input sensitivity to either ON - 1V or OFF - 100mV.

**Switch 4** - Input 1 Select - OFF - Mic, ON - Line

### DIP 2

**Switch 1** - ON - Enables Phantom power to the Mic on input 2.

**Switch 2** - ON - Sets Input 2 priority or VOX to ON.

**Switch 3** - Sets Line 2 input sensitivity to either ON - 1V or OFF - 100mV.

**Switch 4** - Input 2 Select - OFF - Mic, ON - Line

### DIP 3

**Switch 1** - ON - Enables Phantom power to the Mic on input 3.

**Switch 2** - ON - Sets Input 3 priority or VOX to ON.

**Switch 3** - Sets Line 3 input sensitivity to either ON - 1V or OFF - 100mV.

**Switch 4** - Input 3 Select - OFF - Mic, ON - Line

### DIP 4

**Switch 1** - ON - Enables Phantom power to the Mic on input 4.

**Switch 2** - ON - Sets Input 4 priority or VOX to ON.

**Switch 3** - Sets Line 4 input sensitivity to either ON - 1V or OFF - 100mV.

**Switch 4** - Input 4 Select - OFF - Mic, ON - Line

### DIP 5

**Switch 1** - Sets AUX 1 input sensitivity to either ON - 1V or OFF - 100mV.

**Switch 2** - Not Used.

**Switch 3** - Not Used.

**Switch 4** - Sets AUX 2 input sensitivity to either ON - 1V or OFF - 100mV.

### DIP 6

**Switch 1** - Sets AUX 3 input sensitivity to either ON - 1V or OFF - 100mV.

**Switch 2** - Not Used.

**Switch 3** - Not Used.

**Switch 4** - Sets AUX 4 input sensitivity to either ON - 1V or OFF - 100mV.

Input 1: When VOX is enabled on input 1 it will override inputs 2 - 4 and input 5 (AUX1 - AUX4).

Input 2: When VOX is enabled on input 2 it will override inputs 3 - 4 and input 5 (AUX1 - AUX4).

Input 3: When VOX is enabled on input 3 it will override inputs 4 and input 5 (AUX1 - AUX4).

Input 4: When VOX is enabled on input 4 it will override input 5 (AUX1 - AUX4).

DIP 7 sets the functionality of the Alert/Evacuation/Chime outputs

### DIP 7

**Switch 1** - ON - Hold trigger contact closed to play, OFF - Hold trigger contact closed momentarily to play.

**Switch 2** - ON - Mic 1 Overrides A 4433 plate volume

**Switch 3** - ON - Activates MIC pre-announcement chime (activated by PTT on mic inputs)

**Switch 4** - ON - Chime1 Play Once, OFF - Chime1 Repeats

**Switches 5-8** - Sets the Alert to Evacuation tone change-over time (refer to figure 4).

### DIP 7

#### Alert -Evac Timer Settings

Time (sec)	DIP switch			
	5	6	7	8
30	on	off	off	off
60	off	on	off	off
90	on	on	off	off
120	off	off	on	off
150	on	off	on	off
180	off	on	on	off
210	on	on	on	off
240	off	off	off	on
270	on	off	off	on
300	off	on	off	on
330	on	on	off	on
360	off	off	on	on
390	on	off	on	on
420	off	on	on	on
450	on	on	on	on

Fig 4.

#### IMPORTANT NOTE:

Ensure power is switched off when adjusting DIP switches.  
New settings will be effective when power is switched back on.



## 8.0 ALERT, EVACUATION and CHIME MP3 FILES and ALERT and EVAC VOICE OVER MESSAGES

The supplied Micro SD card houses all the MP3 audio files used for the output tones. These files are stored in five separate folders (see figure 5) and relate to the corresponding output. e.g. the Alert folder houses the MP3 file to be played when the Alert mode is triggered.

These files can be any length and bit rate, but must be in MP3 format (they cannot be Wav files or AAC files).

*(NOTE: only one MP3 file can be in each folder).*

There is also a folder labelled "#LIBRARY#" which contains a host of sample MP3 files.

The "Voice" folder contains the MP3 audio files played as the Alert and Evacuation messages. There are separate folders for both the Alert and Evacuation messages as shown in figure 5.

The messages have to be recorded in MP3 format using any readily available PC software or other means, and then transferred to these folders.

### Activating the Voice Over Message:

Voice over messages become active when an MP3 file is present in the relevant folder. If the voice over message is not required leave the folder empty.

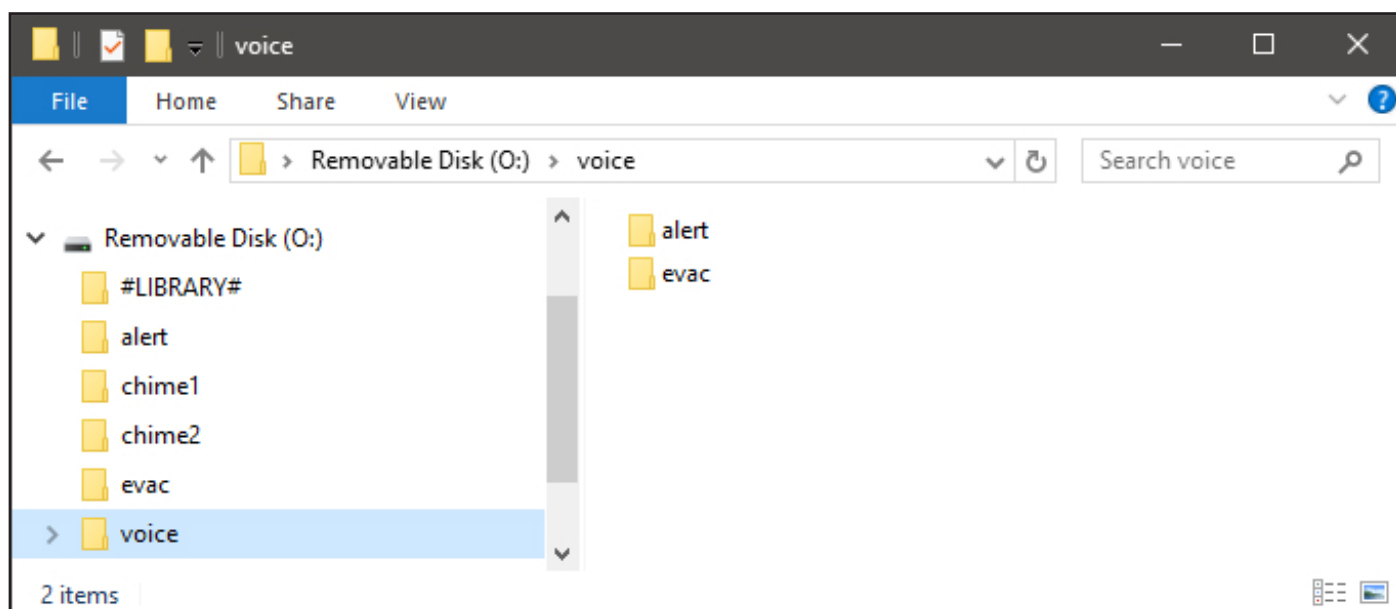

Fig 5

## 9.0 INSTALLING MP3 FILES

You will first need to remove power from the A 4432 then remove the Micro SD card from the rear of the unit. To remove the Micro SD card push the card in and it will eject itself.

In order to access the program, the Micro SD card will need to be connected to a PC. You will need a PC or laptop equipped with an Micro SD card reader to do this. If a Micro SD slot is not available then the Altronics D 0371A USB Memory Card Reader or similar would be suitable (not supplied).

### Step by step guide to installing an MP3 onto the Micro SD card with a Windows installed PC

Make sure the PC is on and card reader connected and correctly installed. Then insert the Micro SD card into the reader. Go to "My Computer" or "This PC" and open the Micro SD card which is usually marked "Removable disk".

In this case it is named "Removable disk (O:)" as shown in figure 6.

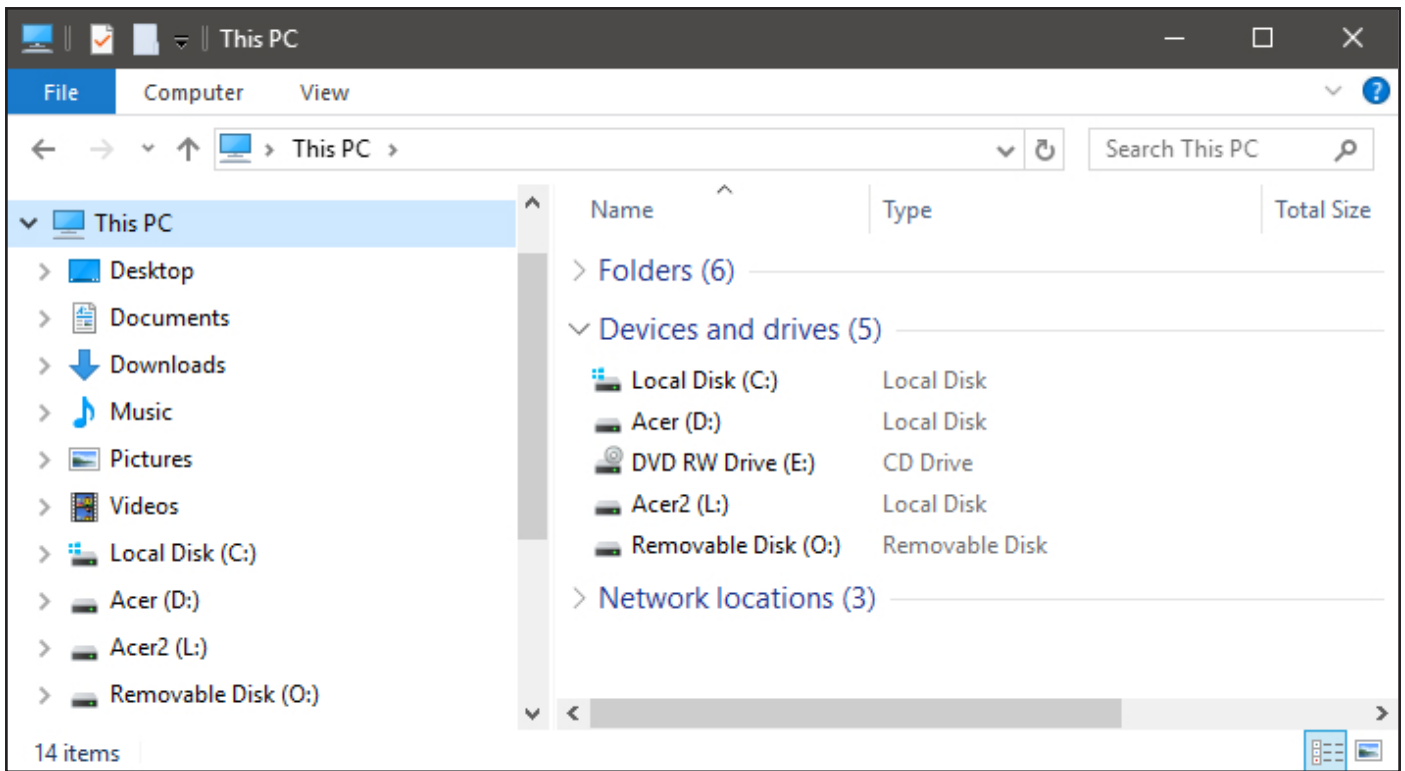

Fig 6

Open the Removable Disk and you should get a window that looks like figure 7.

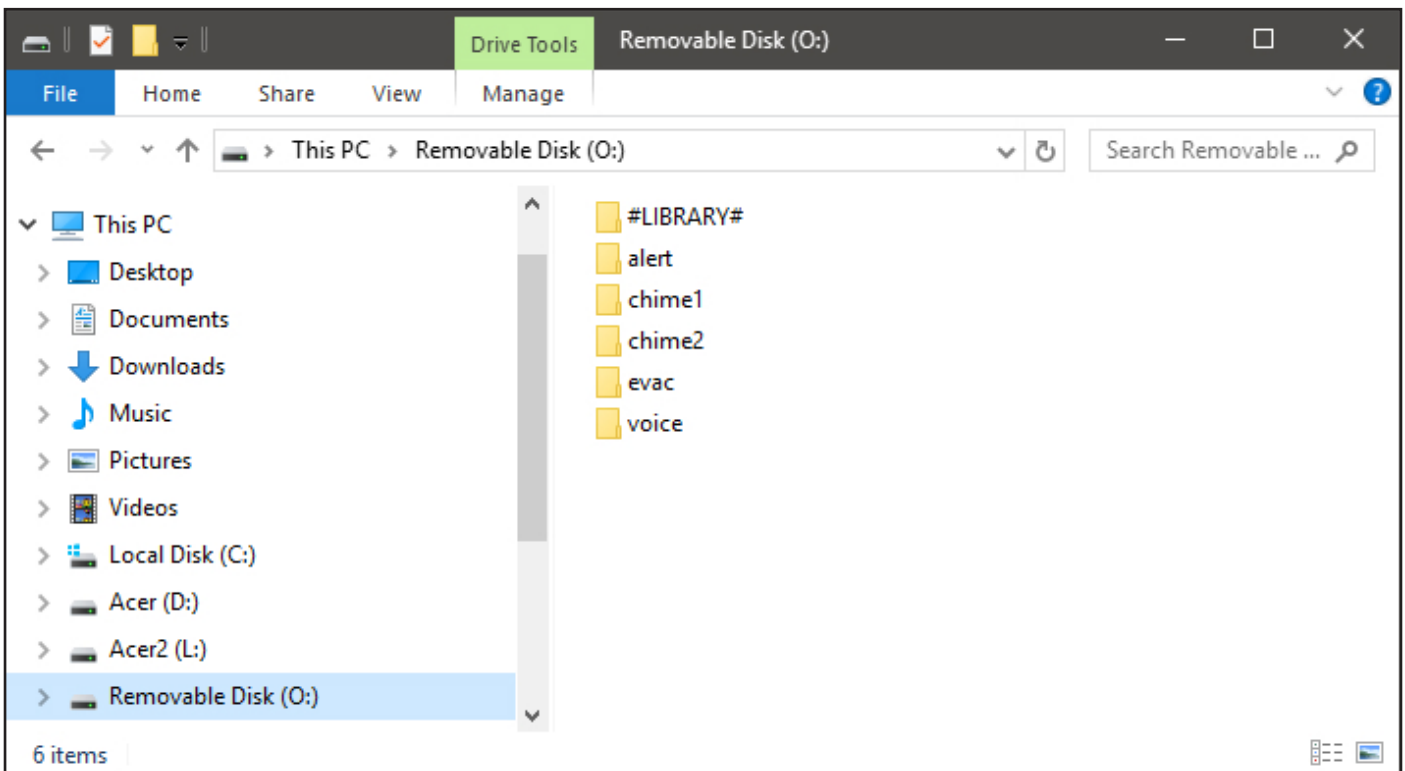

Fig 7

The contents of the SD Card include a Library folder of sample MP3 files and five folders for the MP3 files associated with the various triggers. There should be default MP3 files included in each folder. These will need to be replaced with your own MP3 files.

Open the folder in which you want to install an MP3 (in our case its the Alert folder) and you should see an MP3 file which is named Alert.MP3 as shown in figure 8.

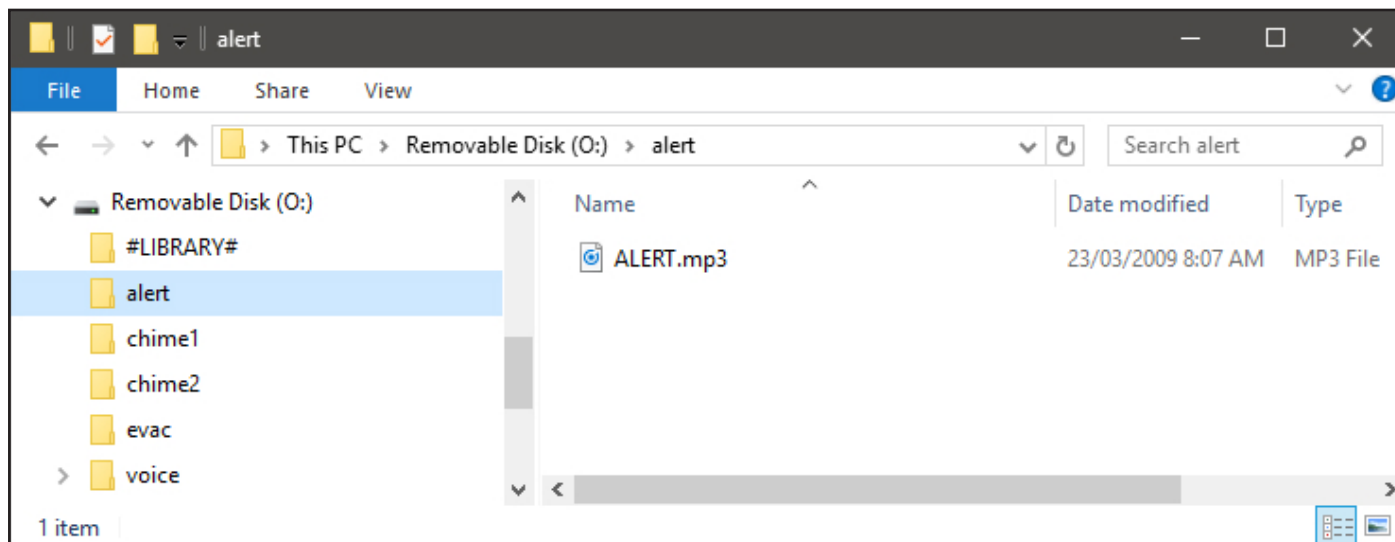

Fig 8

This MP3 file needs to be deleted and replaced by the MP3 file you want to play when you activate the Alert mode. The MP3 file name is not important. But it is important that there is only one MP3 file in the Alert folder.

Check the properties of the MP3 file.

*NOTE the new MP3 file cannot be "Read only".*

To check this, right click on the MP3 file and scroll down and select Properties, you will get a window that looks like figure 9.

Make sure the "Read Only" box has no tick in it.

The new MP3 is now installed on the card. Repeat these steps for the other MP3 folders if you need to.

The card can be removed from the PC following windows safe card removal procedures. Make sure the A 4432 is OFF and insert the SD card into the slot in the rear; it will click when fully inserted. The A 4432 is ready to use.

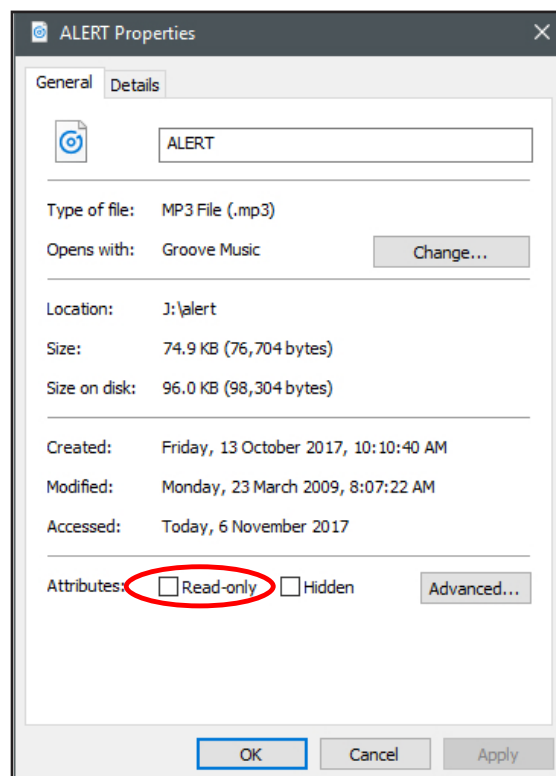

Fig 9

# Redback® A 4432 4+4 Channel Mixer

## 10.0 A 4433 AUX MUSIC SOURCE SELECTOR WALL PLATE

The A 4433 wall plate allows remote selection of the A 4432's input audio source and volume level.

In addition, when connected to the A 4931 local input wallplate or A 4932 local input box, it allows the use of a local signal source, such as a wired mic, radio mic or aux source such as a mobile device, which VOX mutes the selected input from the A 4432.

The LCD displays the input sources and zone and local input volume levels.

**Note:** The volume controls only adjust the volume of the four aux input sources, plus the local input (when used).

### 10.1 A 4433 Features

- Remote selection of input audio source
- Volume control of zone input
- Volume control of local input
- Mute function
- Zone Lockout
- Personal Identification Number (PIN) Menu Lockout Function
- 2 stage wall plate functionality Lockout
- Provision for input of local microphone or line level audio via A 4931 plate
- Cat5e connection to A 4432
- Powered from the A 4432

### 10.2 A 4433 Menu Accessed Features

- Enable/Disable Local Input
- Clock Time Adjustment
- Backlight Timeout Adjustment
- Change Zone (Wall plate ID)
- Button actions adjustment
- Vox Sensitivity Level Adjustment
- Disable Input Sources
- Change Pin Number
- Lock/Unlock Screen



A 4433

### 10.3 A 4433 Connection Details

- 1 Backup battery (CR2032). This is used to backup the clock time if the power is removed.
- 2 Micro SD card socket. This is used for storage of the Audio input labels and for Firmware updates. To remove, disconnect power from the A 4432 and then Push to Eject the SD card.
- 3 RJ45 connection. This is connected to the A 4432 via Cat5e or Cat6 cable.
- 4 RJ45 connection. This is connected to the A 4931 Local Input Wall Plate or A 4932 Local Input Box if used via Cat5e or Cat6 cable.

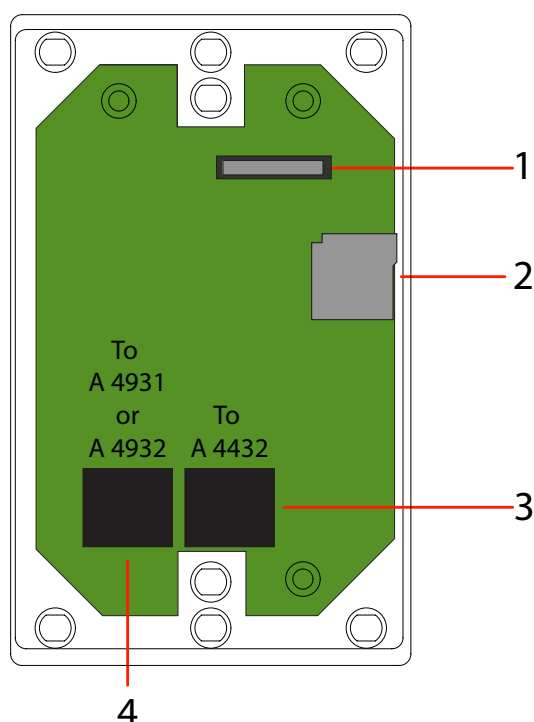

Fig 10. Rear of plate

## 10.4 A 4433 Screen Layout Guide

Fig 11 shows the layout of the A 4433 LCD.

**1 Input selection buttons 1-4**  
Use these buttons to select the desired input source.

**2 Local Input Button**  
Press this button to activate the local input. If an A 4931 local input wall plate or A 4932 local input box is connected to the A 4433 wall plate then any audio from this plate will override the zone input. The button will change to red when active.

**3 Local input volume up button**  
Press this button to increase the local input volume.

**4 Local input volume bar graph indicator**  
This bar provides a quick visual indicator of the local input volume.

**5 Local input volume down button**  
Press this button to decrease the local input volume.

**6 Sound indicator button**  
Press this button to mute/enable the sound. The button will change to red when the output is muted.

**7 Menu button**  
Use this button to enter the Menu functions. The menu screen is explained in section 10.5.

**8 Zone volume down button**  
Press this button to decrease the zone volume.

**9 Zone volume bar graph indicator**  
This bar provides a quick visual indicator of the zone volume.

**10 Zone volume up button**  
Press this button to increase the zone volume.

**11 Clock display**  
This time and day display is local to this plate only and is set by accessing the "menu/change time" option (refer to section 7.0 for more details). This time needs to be set for each plate by the user and has no correlation to the A 4432 which has no time facility. The time is backed up by the supplied CR2032 battery which needs to be inserted into the battery holder as shown in figure 1. Note the battery will backup the time for months only. Remove the battery if power is to be removed for long periods of time.

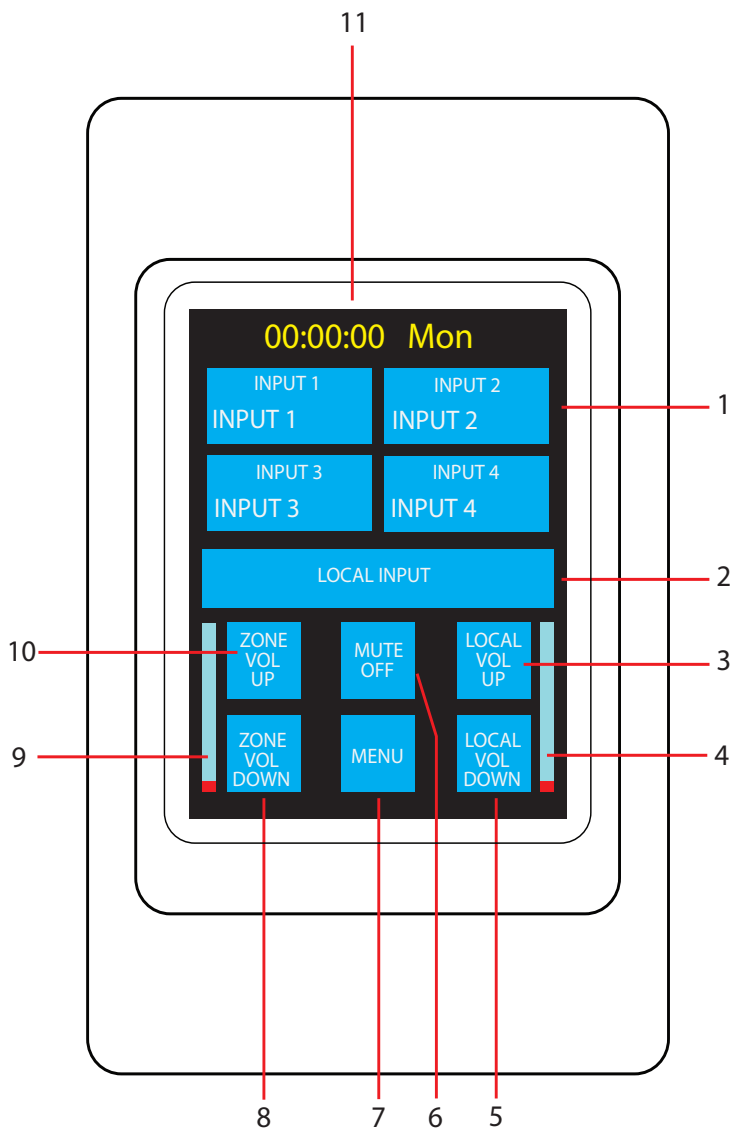

Fig 11

# Redback® A 4432 4+4 Channel Mixer

## 10.5 Navigating The A 4433 Menu

The menu button provides access to a host of options which are listed below.

Note : Access to the Menu can be restricted to only be available with a Personal Identification Number (PIN). This can be activated by setting DIP Switch 1 to "ON" (See DIP settings).

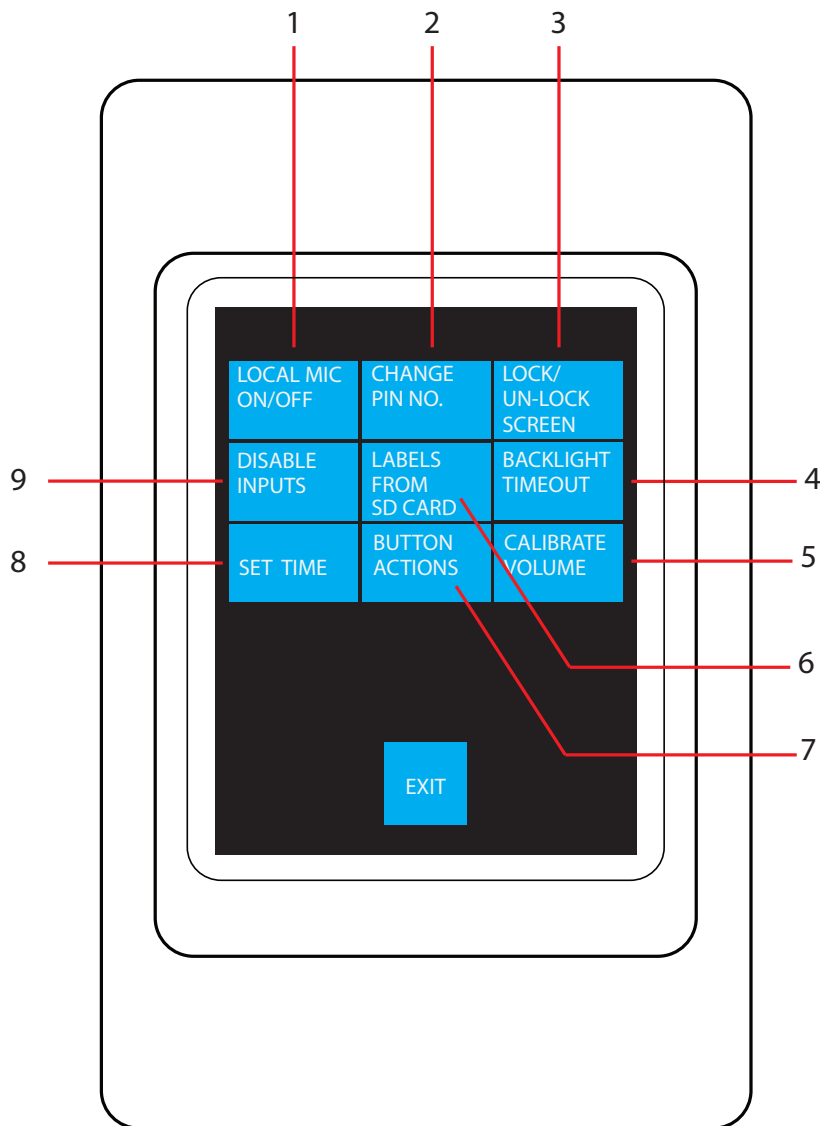

Fig 12. A 4433 Menu Screen

### 1) Local Mic On/Off

The local input from the optional A 4931 Zone Mic/Line Wall Plate or A 4932 Zone Mic/Line Preamp Box can be enabled/ disabled. Press the button and follow the prompts to disable/hide the local input button and volume controls. Once hidden the local input icons will be greyed out. They are no longer accessible from the main screen. To enable/show the local input press the button and follow the prompts.

### 2) Change Pin Number

A Personal Identification Number (PIN) can be set for access to the Menu function. The pin number can be changed by pressing this button and following the prompts.

### 3) Lock/Unlock Screen

There are two levels of user lockout available.

The first level locks the inputs so that the input source cannot be changed by pressing the input buttons on the LCD.

Note : The volume and mute buttons are still accessible at this lockout level.

The second level locks out the entire wall plate so that none of the buttons function.

Press the Lock/Unlock Screen button and follow the prompts. Note: To unlock the plate after locking the first level, the user will have to proceed to the Lock Entire plate function and then have access to the Unlock function.

## 4) Backlight Timeout

The time the backlight remains on after the screen has been touched can be adjusted. The time can be adjusted between 0 and 600 seconds. Setting the time to zero keeps the backlight on continually. Set the time to 1 sec and the backlight will turn off after 1 sec etc.

## 5) Calibrate Volume

This option has been made available in the event that the volume will not reach the full 100% maximum level or will not reach the 0% minimum level. Small adjustments can be made which shift the volume scale up or down.

## 6) Labels From SD Card

The labels used on the Input buttons on the A 4433 can be user defined to any text description to a maximum of 12 characters. Use this function to Import the Audio Input Button Labels which are stored on the Micro SD Card. Pressing this button will automatically import the labels from the configuration files found on the Micro SD card. See section 5.3 for more details.

## 7) Button Actions

The buttons can be set to have visual, vibration and sound feedback by accessing this menu function.

There are three different actions available for button presses.

- BEEP - a buzzer will sound each time a button is pressed.
- HARPIC - the wall plate will vibrate each time a button is pressed.
- BACKLIGHT TOGGLE - the LCD backlight will toggle OFF and ON for each button press.

Each of these can be turned ON or OFF independently via this menu function.

## 8) Set Time

The time displayed on the main screen can be adjusted here. The hour, minute and day can be all be modified (Note: there is no seconds displayed). The time is backed up by a CR2032 battery (supplied).

## 9) Disable Inputs

By using this function any of the four input sources can be disabled, so that they are not available to the zone. Press the Disable Inputs button and then highlight the zones to be disabled. Once the inputs are disabled the buttons will be displayed in a light grey colour on the LCD. These highlighted buttons are now inaccessible.

## 10.6 Connecting the A 4433 wall plate to the A 4432 Mixer

The A 4433 Input Selector plate is connected to the A 4432 Mixer via a Cat5e or Cat6 cable and is connected as shown below.

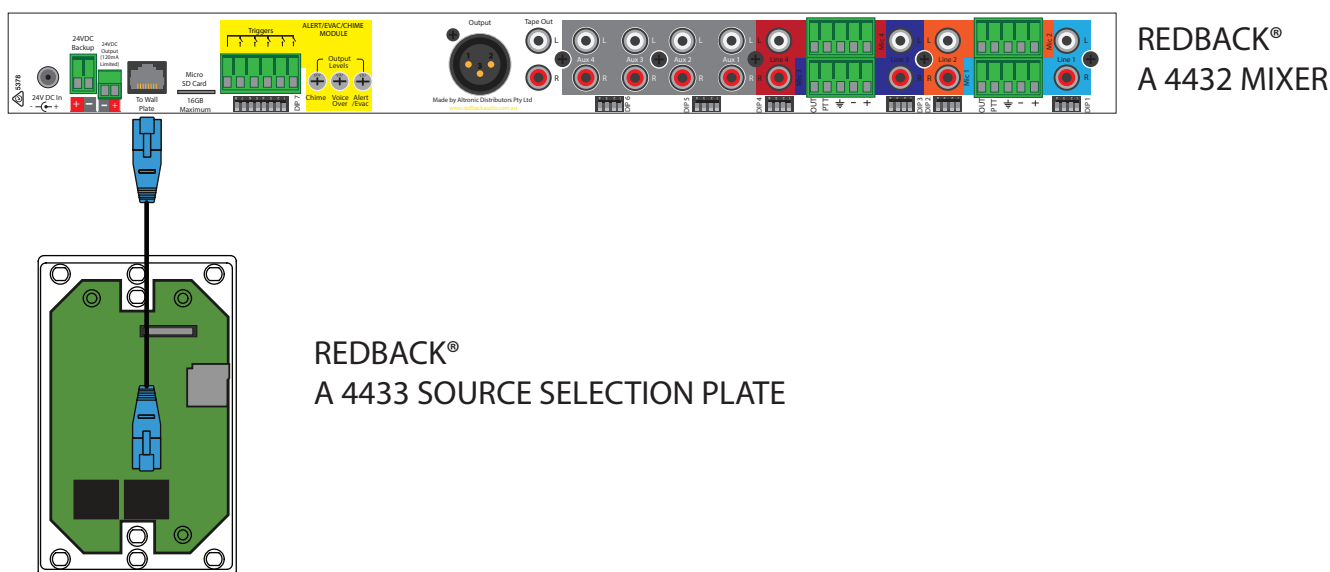

# Redback® A 4432 4+4 Channel Mixer

## 10.6 Editing The A 4433 Audio Input Button Labels

The Audio Input Button labels are stored on the Micro SD card located in the side of the A 4433 wall plate. In order to edit the audio input labels the Micro SD card needs to be removed and then connected to a PC or Laptop. To remove, disconnect power from the A 4432 and then Push to eject the Micro SD card.

Once removed the Micro SD card will need to be connected to a PC. You will need a PC or laptop equipped with a Micro SD card reader to do this. If a Micro SD slot is not available then the Altronics D 0371A USB Memory Card Reader or similar would be suitable (not supplied).

Make sure the PC is on and card reader connected and correctly installed. Then insert the Micro SD card into the reader. Go to "My Computer" or "This PC" and open the SD card which is usually marked "Removable disk".

In this case it is named "Removable disk (O:)" as shown in figure 13.

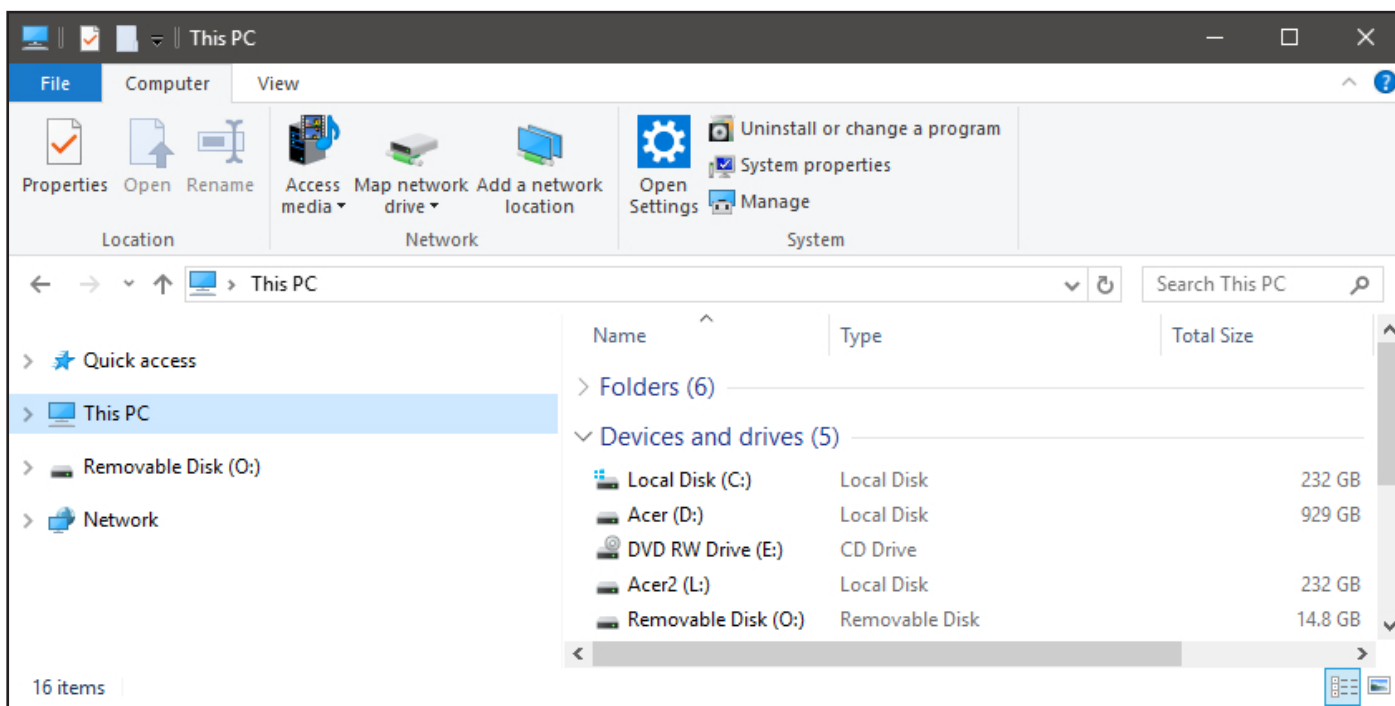

Fig 13

Open the Removable Disk and you should get a window that looks like figure 14.

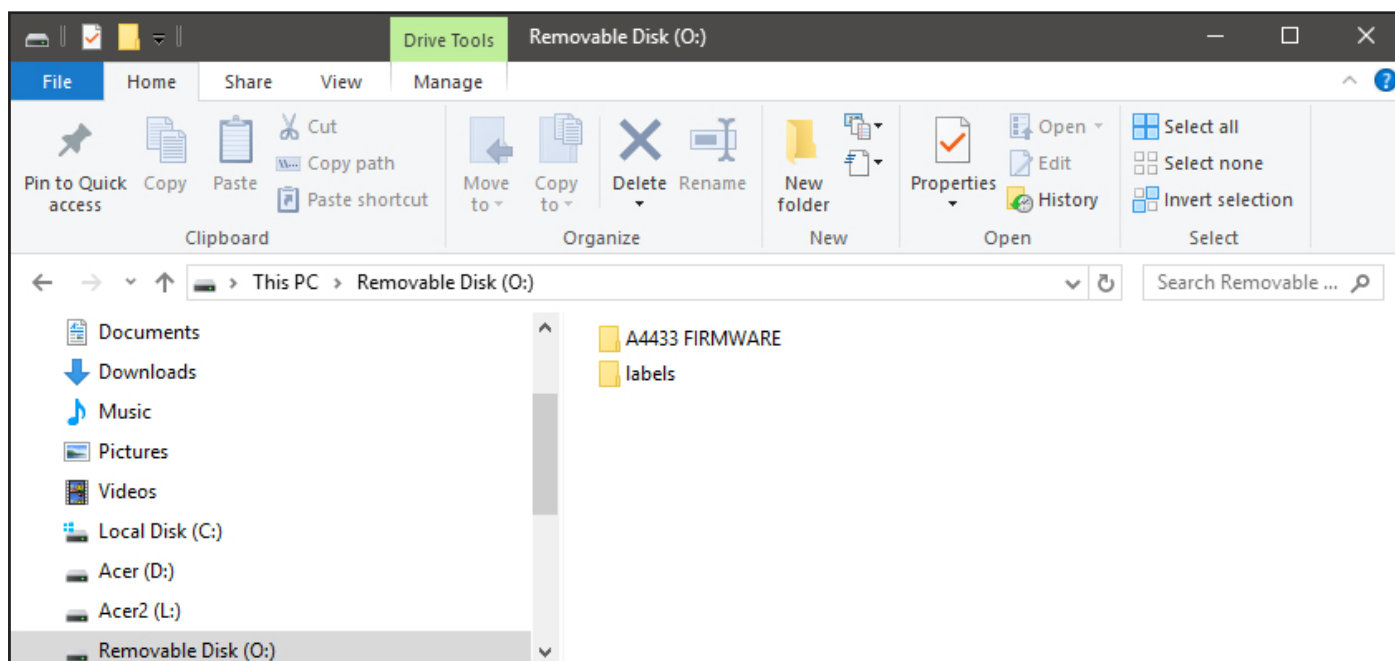

Fig 14



The Micro SD card contains two folders, the Labels folder and the A 4433 Firmware folder. The Labels folder contains the files used for the naming of the Audio Input Sources. The A 4433 Firmware folder is supplied in the event that the wall plate needs to be restored to its original firmware. Open the Labels folder and you should see a window that looks like figure 15.

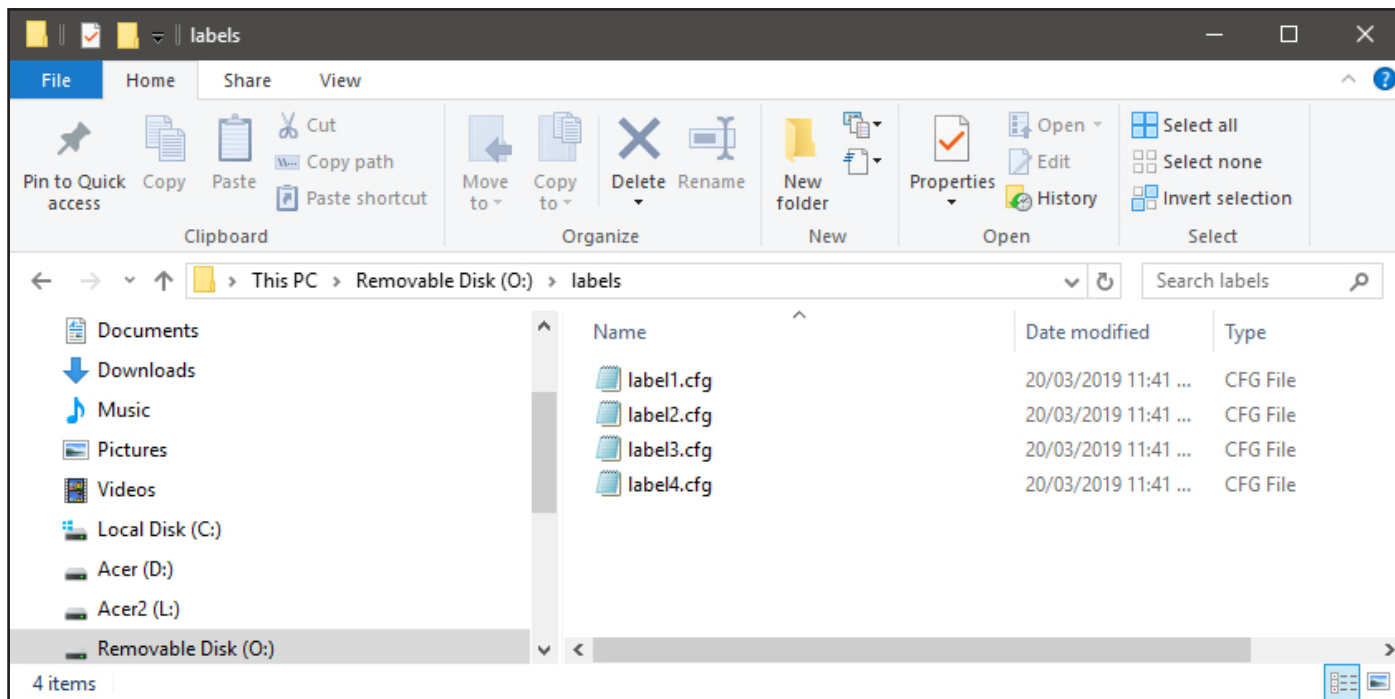

Fig 15

The contents of the “Labels” folder include four files as shown. These files can be opened with a simple text editor such as Notepad. Label1.cfg relates to button 1 on the A 4433 wall plate, label2.cfg to button 2 and so on. Open the file by double clicking on it and then using a program such as notepad, the file will open and look like the image shown in figure 16.

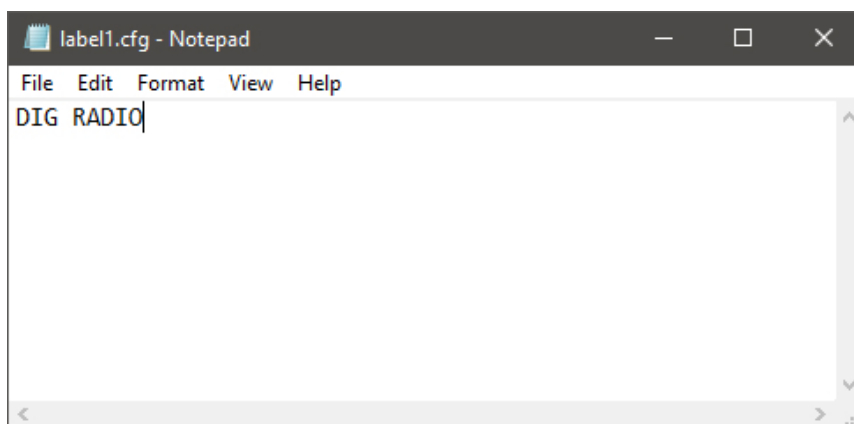

Fig 16

The label in the image shown is “DIG RADIO”. Simply rename this text to the desired label and then save the file.

*NOTE: The description for the label has a maximum of 12 characters.*

Repeat this procedure for all cfg files making sure to save them.

Remove the Micro SD card from the PC or laptop using safe removal procedures and then re-insert into the A 4433 wall plate.

Power up the A 4432, press the “Menu” button and then select the “Labels From SD Card” option from the menu. The new labels will be automatically uploaded from the Micro SD card to the A 4433 wall plate.

# Redback® A 4432 4+4 Channel Mixer

## 10.7 Local Microphone/Line Input Wall Plate Or Box

The A 4931 Zone Mic/Line Wall Plate or A 4932 Zone Mic/Line Preamp Box provide a means of overriding the input to a zone with a local input source located in that zone. An example may be a mobile phone for background music or a microphone for speeches at a wedding function. Both the wall plate and box have connections for a 3 pin XLR microphone, dual RCA line level input and a 3.5mm line level input for portable devices.



Fig 17. Front View of A 4931 Local Input Wall Plate and A 4932 Local Input Box

The A 4931 or A 4932 have to be connected to the A 4433 Input Selector plate via a Cat5e cable and is connected as shown in fig 18.

*NOTE: The A 4433 remote plate can have only one of the A 4931 local input plate or A 4932 local input boxes connected.*

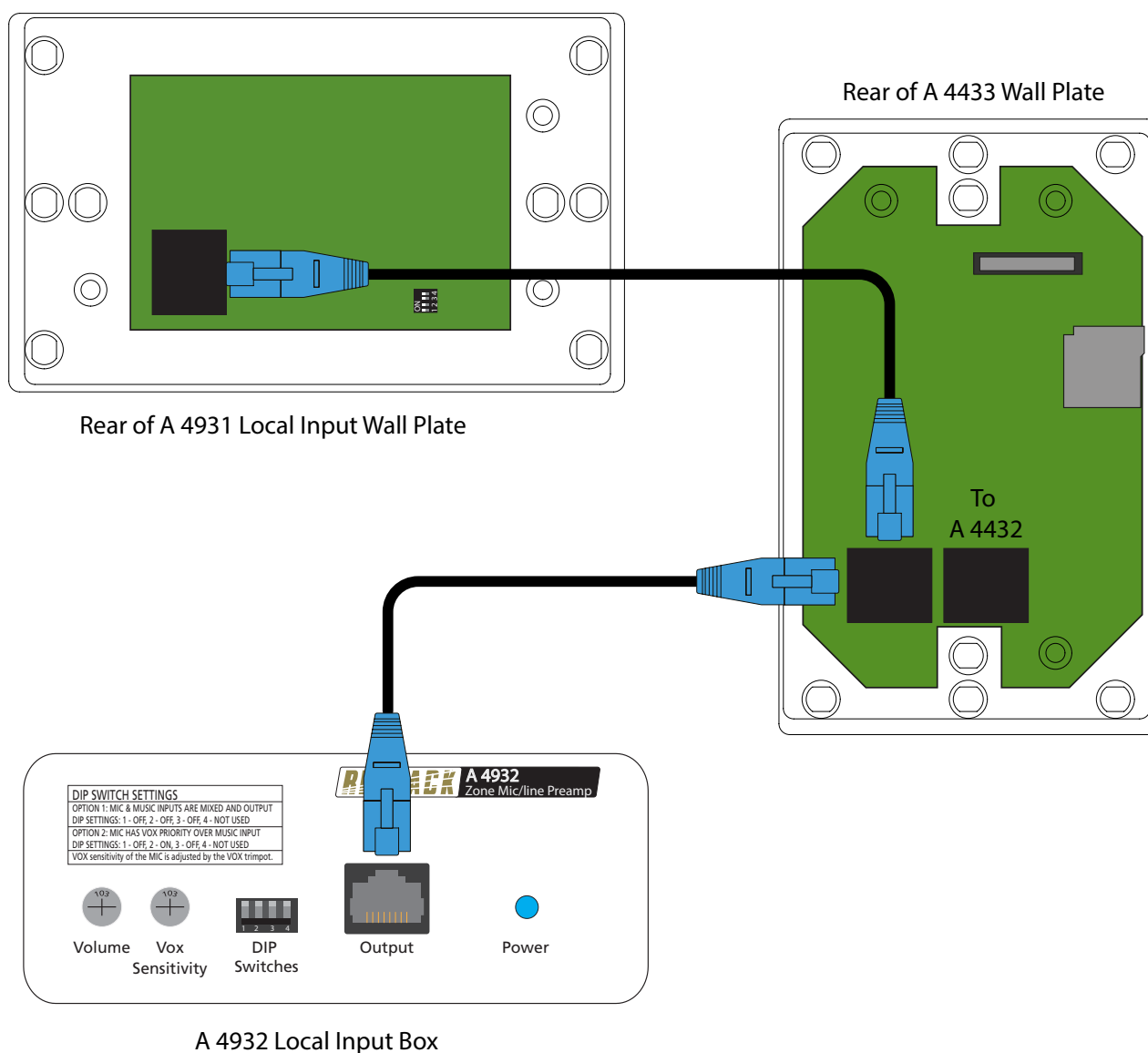

Fig 18. Connection of the A 4931 Local Input Wall Plate or A 4932 Local Input Box to the A 4433 Input Source Wall Plate

## 10.8 A 4931 and A 4932 DIP Switch Settings

The A 4931 and A 4932 have a set of DIP switches on the rear which determine how the audio is output. The DIP switches are labelled 1) VOX BOTH, 2) VOX ENABLE, 3) VOX OUTPUT.

When the A 4931/32 is used with the A 4433 there are only two possible audio output options.

1) The audio from the A 4931/32 microphone input and the line and/or music inputs are mixed together and output to the A 4433

DIP Switches set as follows: 1-OFF ,2-OFF, 3-OFF

2) The A 4931/32 microphone input has VOX priority over the line and music inputs. I.e. the audio from the line/Music inputs will be over ridden by the Mic input when a microphone is used.

DIP Switches set as follows: 1-OFF ,2-ON, 3-OFF.

The VOX sensitivity of the microphone is adjusted by the trimpot on the rear of the A 4931/32 labelled "VOX" or "VOX sensitivity".

## 11.0 TROUBLE SHOOTING

If the REDBACK A 4432 mixer fails to deliver the rated performance, check the following:

### No Power, No Lights

The standby switch is used to turn the unit on. Make sure this switch has been pressed.

Make sure mains power switch is on at the wall.

Check the supplied plugpack is connected correctly.

### MP3 files not playing

The files must be MP3 format. Not wav, AAC or other.

Check Micro SD card is inserted correctly.

### DIP switch changes not effective

Turn the unit OFF before changing DIP switch settings. Settings become effective after power is returned.

## 12.0 FIRMWARE UPDATES

It is possible to update the firmware for both the A 4432 Mixer and the A 4433 wall plate by downloading the relative update version from [www.altronics.com.au](http://www.altronics.com.au) or [redbackaudio.com.au](http://redbackaudio.com.au).

To perform an update, follow these steps.

- 1) Download the Zip file from the website.
- 2) Remove the Micro SD card from the A 4432 or A 4433 and insert it into your PC.
- 3) Extract the contents of the Zip file to the root folder of the Micro SD Card.
- 4) Rename the extracted .BIN file to update.BIN.
- 5) Remove the Micro SD card from the PC following windows safe card removal procedures.
- 6) With the power turned OFF, insert the SD card back into the A 4432 or A 4433.
- 7) Turn the A 4432 ON. The unit will check the SD card and if an update is required the A 4432 or A 4433 will perform the update automatically.

# Redback® A 4432 4+4 Channel Mixer

## 13.0 A 4432 SPECIFICATIONS

**OUTPUT LEVEL:**.....0dBm

**DISTORTION:**.....0.01%

**FREQ. RESPONSE:**.....140Hz - 20kHz

### SENSITIVITY

Mic inputs: .....3mV balanced

Line inputs:.....100mV-1V

Aux inputs:.....100mV-1V

### OUTPUT CONNECTORS

Line out: .....3 pin XLR balanced

Switched out: .....Screw terminals

### INPUT CONNECTORS

Inputs: .....5 pin euro connectors or 2 x RCA  
..... 3.5mm stereo jack front panel

24V DC power: .....Screw terminals

24V DC Power: .....2.1mm DC Jack

Remote triggers: .....Screw Terminals

### CONTROLS:

Power:.....Standby Switch

Bass:.....±10dB @ 100Hz

Treble:.....±10dB @ 10kHz

Master: .....Volume

Inputs 1-5: .....Volume

**INDICATORS:**.....Power on, MP3 error,  
.....MP3 active, Signal Present, VU Meter

**POWER SUPPLY:**..... 24V DC

**DIMENSIONS:**≈..... 482W x 175D x 44H

**WEIGHT:** ≈..... 2.1 kg

**COLOUR:** .....Black

All Australian made Redback products are covered by a 10 year warranty.

Should a product become faulty please contact us to obtain a return authorisation number. Please ensure you have all the relevant documentation on hand. We do not accept unauthorised returns. Proof of purchase is required so please retain your invoice.

\* Specifications subject to change without notice