

ALTRONICS S 5062D 6V 1.3Ah SLA Battery

Specifications

Nominal Voltage		6 V
Capacity (25°C)	20HR(5.25V)	1.3Ah
	10HR(5.25V)	1.1Ah
	1HR(4.80V)	0.78Ah
Dimension	Length	97± 1mm (3.82inch)
	Width	24± 0.5mm (0.94inch)
	Height	52± 1mm (2.05inch)
	Total Height	58± 1mm (2.28inch)
Approx. Weight		0.29kg (0.64lbs)± 5%
Terminal type		F1
Internal resistance (Fully charged, 25°C)		Approx. 55mΩ
Capacity affected by temperature (20HR)	40°C	102%
	25°C	100%
	0°C	85%
	-15°C	65%
Self-discharge (25 °)	3 month	Remaining Capacity: 91%
	6 month	Remaining Capacity: 82%
	12 month	Remaining Capacity: 65%
Nominal operating temperature		25°C± 3°C(77°F± 5°F)
Operating temperature range	Discharge	-15 ~50 (5 ~ 122)
	Charge	-10°C~50°C(14°F~ 122°F)
	Storage	-20°C~50 (-4°F~ 122°F)
Float charging voltage(25°C)		6.80 to 6.90V Temperature compensation: -9mV/°C
Cyclic charging voltage(25°C)		7.25 to 7.50V Temperature compensation: -15mV/°C
Maximum charging current		0.36A
Maximum discharge current		18A(5 sec.)
Designed floating life(20)		5 years

Dimensions

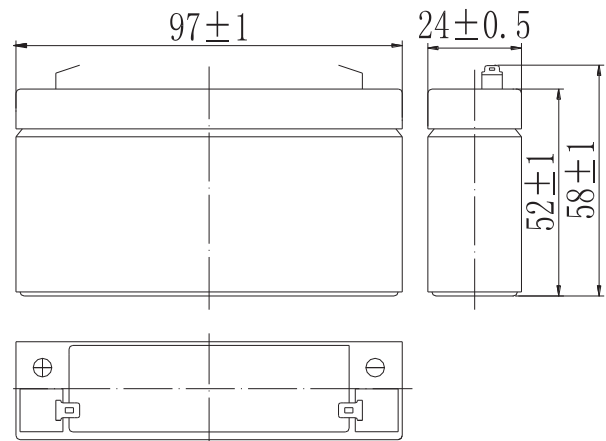

Terminal

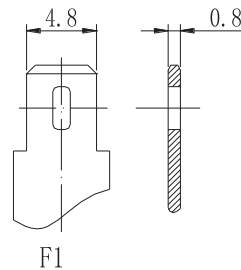

Constant Current Discharge Characteristics (A, 25°C)

F.V/TIME	5min	10min	15min	30min	60min	2h	3h	4h	5h	10h	20h
4.80V	4.58	2.90	2.27	1.28	0.79	0.43	0.30	0.25	0.21	0.11	0.06
4.95V	4.45	2.82	2.21	1.25	0.77	0.43	0.30	0.24	0.21	0.11	0.06
5.10V	4.26	2.70	2.13	1.21	0.75	0.42	0.29	0.24	0.21	0.11	0.06
5.25V	4.08	2.58	2.06	1.18	0.74	0.42	0.29	0.24	0.21	0.11	0.06
5.40V	3.85	2.44	1.95	1.14	0.72	0.41	0.28	0.23	0.20	0.11	0.06

Constant Power Discharge Characteristics (Watt, 25°C)

F.V/TIME	5min	10min	15min	30min	60min	2h	3h	4h	5h	10h	20h
4.80V	25.6	16.4	12.9	7.32	4.55	2.52	1.77	1.47	1.25	0.68	0.37
4.95V	24.8	15.9	12.6	7.18	4.48	2.50	1.76	1.46	1.24	0.68	0.36
5.10V	23.8	15.2	12.2	6.96	4.37	2.48	1.74	1.45	1.23	0.68	0.36
5.25V	22.8	14.6	11.7	6.79	4.28	2.44	1.73	1.44	1.23	0.67	0.36
5.40V	21.5	13.8	11.1	6.54	4.15	2.38	1.68	1.39	1.19	0.66	0.35

Note: The above characteristics data can be obtained within three charge/discharge cycles.

Construction

Component	Positive plate	Negative plate	Container	Cover	Separator	Electrolyte	Safety valve	Terminal
Raw material	Lead dioxide	Lead	ABS	ABS	AGM	Sulfuric acid	Rubber	Copper

Discharge Characteristics(25°C)

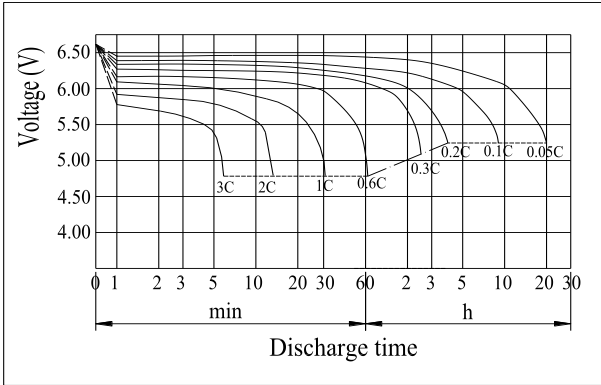

The Relationship for Open Circuit Voltage and Residual Capacity (25°C)

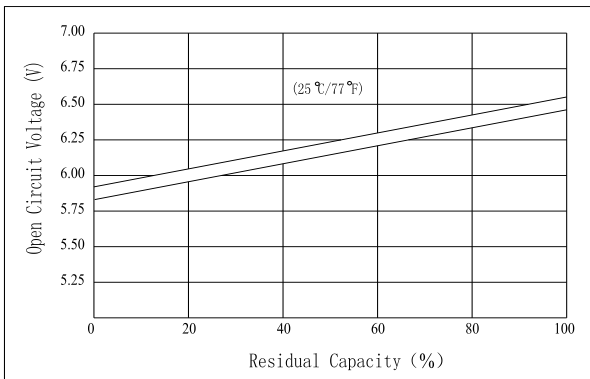

Floating Life on Temperature

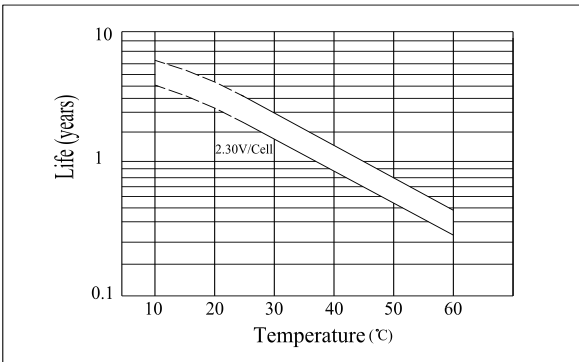

Effect of Temperature on Capacity

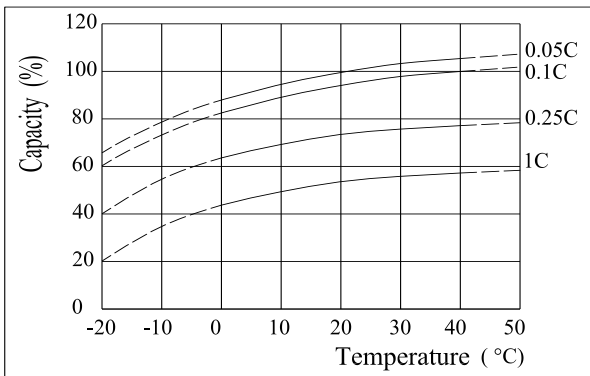

Charging Characteristics(25°C)

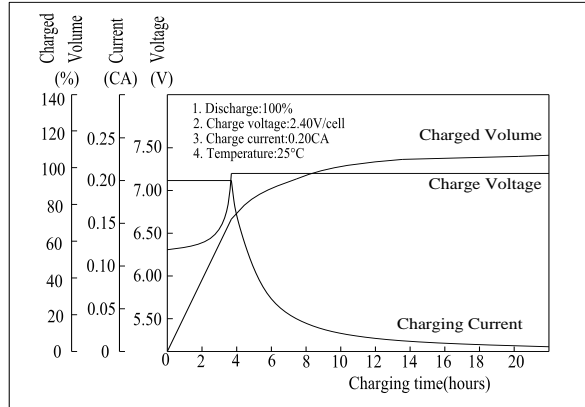

The Relationship for Charging Voltage and Temperature

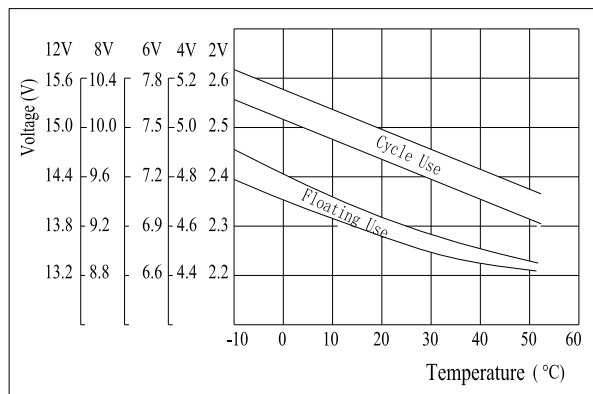

Cycle Life on D.O.D(25°C)

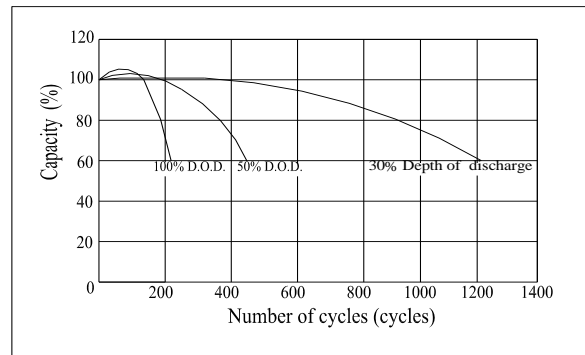

Self-discharge Characteristics

