

FEATURES

SP7.2-12 is a general purpose battery with 3~5 years service life under normal float charge at 25°C. LCB batteries are rechargeable Seal Lead highly efficient, leak proof and maintenance free.



SPECIFICATION

Cell per unit	6	Ambient temperature	
Nominal Voltage (V)	12	Charge	0°C (32°F) to 40°C (104°F)
Nominal Capacity (Ah)	7.2Ah @ 20hour rate F.V(1.75/Cell)	Discharge	-15°C (5°F) to 50°C (122°F)
Weight	Approx 2.30 kg(5.07Lbs.)	Storage	-15°C (5°F) to 40°C (104°F)
Internal Resistance (1KHz)	<25mΩ	Max charge Current	
Max Discharge Current (5s)	108A (5s)	Cycle use :	Max charge current : 2.16A
Battery Life :	Stand by : 3~5 years		Charge voltage: 14.4V to 15.0V
Terminal Type	F1/F2	Stand by :	Charge voltage: 13.5V to 13.8V
Container Material	ABS(Option : 94-HB & 94V-0 flame retardant case)		



DIMENSIONS	Length	Width	Height	Total Height
Unit: mm	151±1	65±1	94±1	100±1
Unit: inch	5.94±0.04	2.56±0.04	3.70±0.04	3.94±0.04

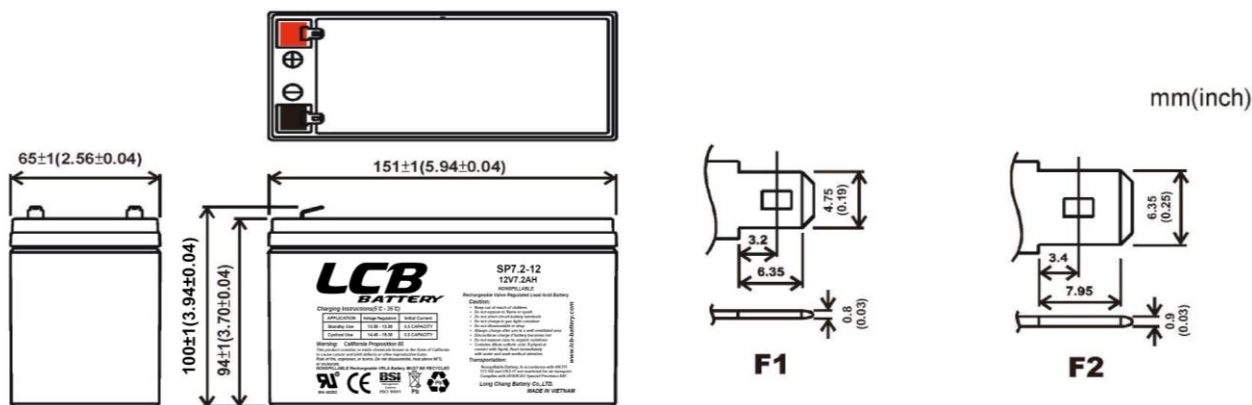

Constant current discharge characteristics Unit:A(25°C 77°F)

F.V/Time	5MIN	15MIN	30MIN	60MIN	2HR	3HR	5HR	8HR	10HR	20HR
1.60V	31.70	14.3	7.85	4.71	2.51	1.88	1.27	0.85	0.70	0.37
1.67V	30.50	14.1	7.68	4.63	2.48	1.83	1.27	0.84	0.70	0.37
1.70V	29.60	14	7.47	4.58	2.45	1.82	1.26	0.84	0.69	0.36
1.75V	27.80	13.8	7.30	4.52	2.35	1.79	1.26	0.84	0.69	0.36
1.80V	26.20	13.5	7.01	4.40	2.26	1.74	1.24	0.82	0.68	0.36

Constant power discharge characteristics Unit:W(25°C 77°F)

F.V/Time	5MIN	15MIN	30MIN	60MIN	2HR	3HR	5HR	8HR	10HR	20HR
1.60V	345	168	106	62.3	36.1	25.7	16.9	11.6	9.56	5.15
1.67V	330	165	105	62.3	36.1	25.7	16.9	11.6	9.54	5.14
1.70V	305	163	104	61.9	36.1	25.7	16.8	11.6	9.51	5.13
1.75V	280	161	103	61.4	35.8	25.5	16.8	11.3	9.46	5.10
1.80V	255	154	100	60.5	35.4	25.2	16.5	11.3	9.36	5.04

Battery Discharge Characteristics (25°C/77°F)

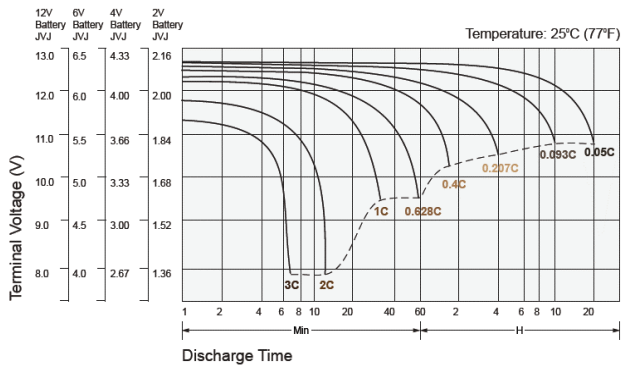

Battery Charge Characteristic for standby use

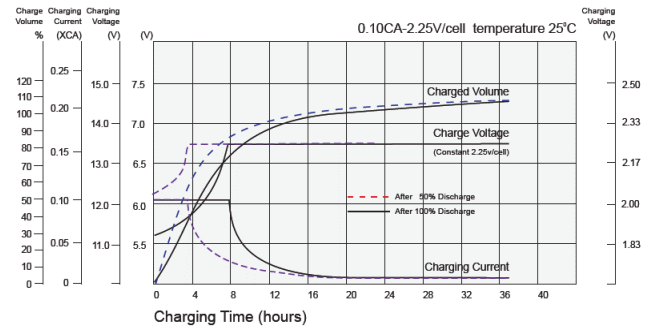

Temperature Effects in Relation to Battery Capacity

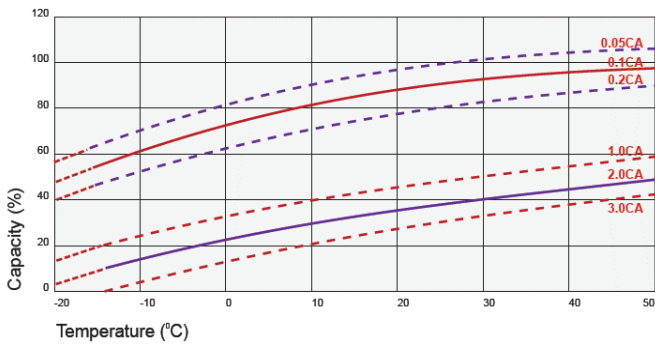

Temperature Effects on Long Term Float Life

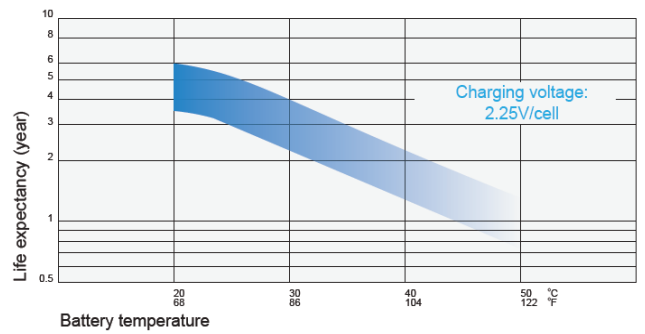

Cycle Service Life

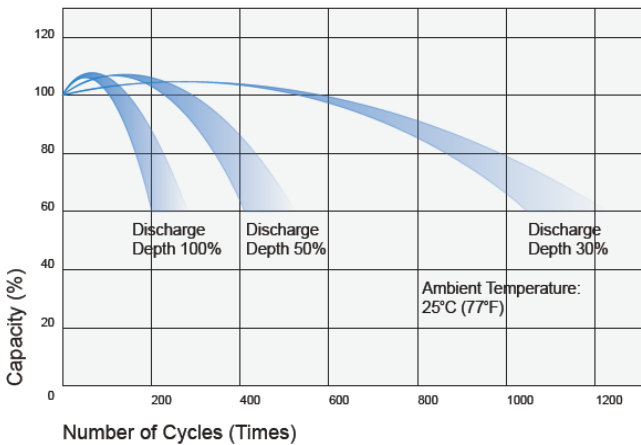

Self Discharge Characteristics

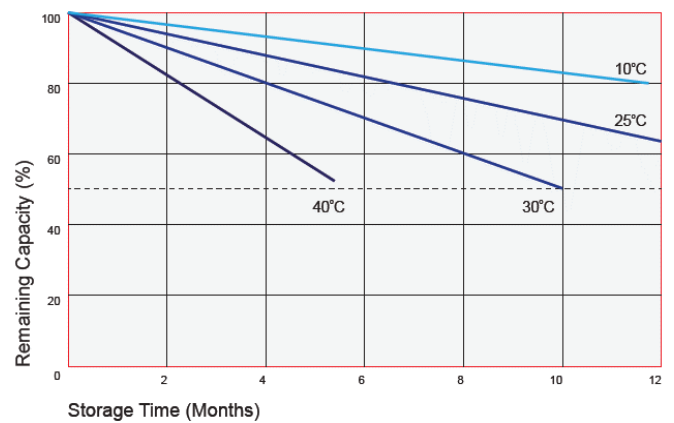

Charging Procedures

Application	Charge Voltage(V/cell)			Max. Charge Current
	Temperature	Set Point	Allowable Range	
Cycle Use	25°C(77°F)	2.45	2.40~2.50	0.25C
Standby	25°C(77°F)	2.275	2.25~2.30	

Discharge Current VS. Discharge Voltage

Final Discharge Voltage V/cell	1.75	1.70	1.65	1.60
Discharge Current (A)	0.2C > (A)	0.2C < (A)	0.5C < (A)	(A) > 1.0C

Taiwan HQ: LONG CHANG BATTERY CO.,LTD	Vietnam Factory: SHENG CHANG TECH. CO., LTD
NO.336,Sec. 1, Yancao Rd. , Fenyuan Shiang, Changhua County 502, Taiwan(R.O.C.)	Lot I 1A –CN- My Phuoc Industrial II, Ben Cat District, Binh Duong Province, Vietnam
TEL:+886-49-2510088 Web: www.lcb.tw	TEL: +84-2743553577
FAX:+886-49-2510099 E-mail: lcb@lcb.tw	FAX: +84-2743553576